

Infrared Receiver Module

IRM-H920X /TR2 series

Features

- high immunity against TFT and plasma backlight
- high immunity against ambient light
- suppresses common IR protocols
- Min burst length: 3 cycles
- Low operating voltage and low power consumption
- long reception range and wide viewing angle
- Pb free and RoHS compliant
- appearance package: black

Description

The device is a miniature type infrared receiver which have been developed and designed by using the latest IC technology. The photo diode and preamplifier are assembled onto a lead frame and molded into an epoxy package which operates as an IR filter. The demodulated output signal can directly be decoded by a microprocessor.

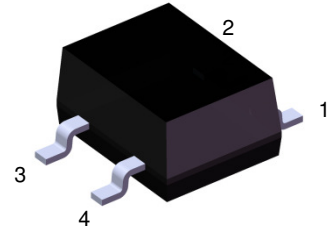

Pin Configuration

1. GND
2. GND
3. Out
4. V_{CC}

Applications

- 3D TV shutter glasses

Application Circuit

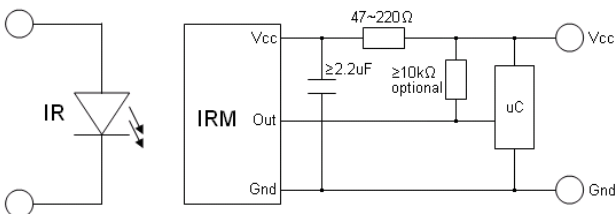

The RC Filter must be connected as close as possible to Vcc and GND pins.

Block Diagram

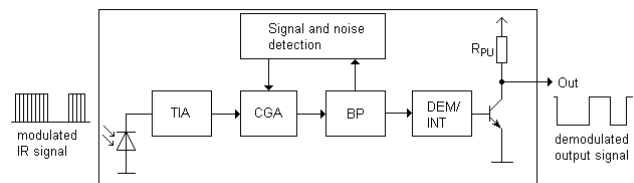

Infrared Receiver Module

IRM-H920X /TR2 series

Parts Table

Model No.	Carrier Frequency
IRM-H920J5/TR2	20 kHz
IRM-H920J5F1/TR2	20KHz

Package Dimensions

(Dimensions in mm)

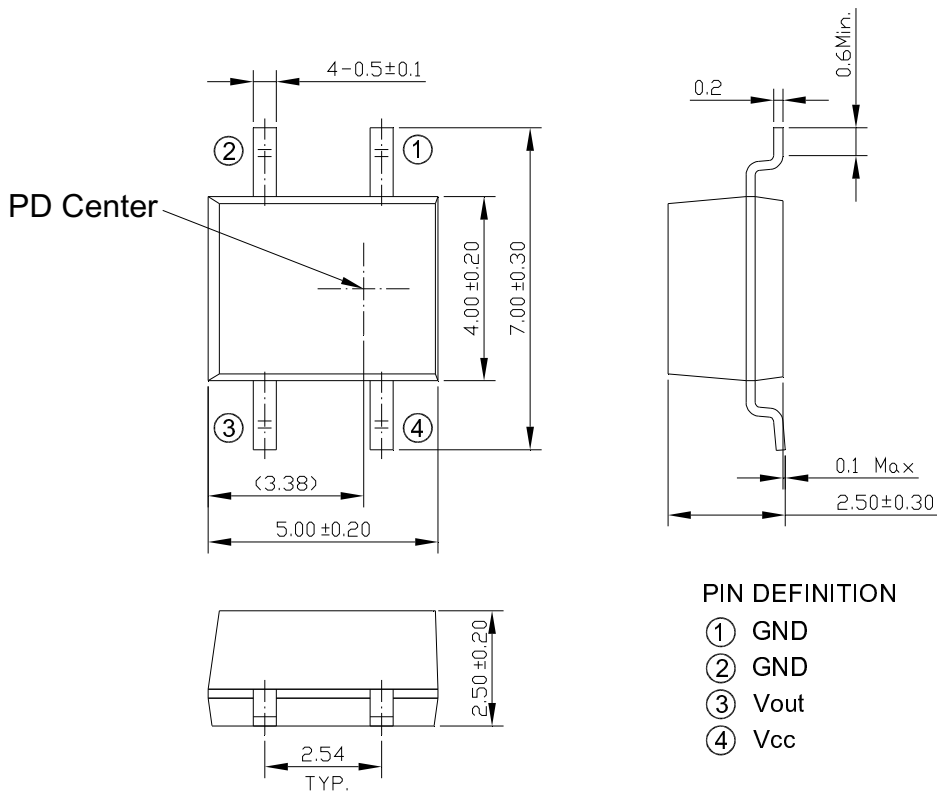

Infrared Receiver Module

IRM-H920X /TR2 series

F1 Type

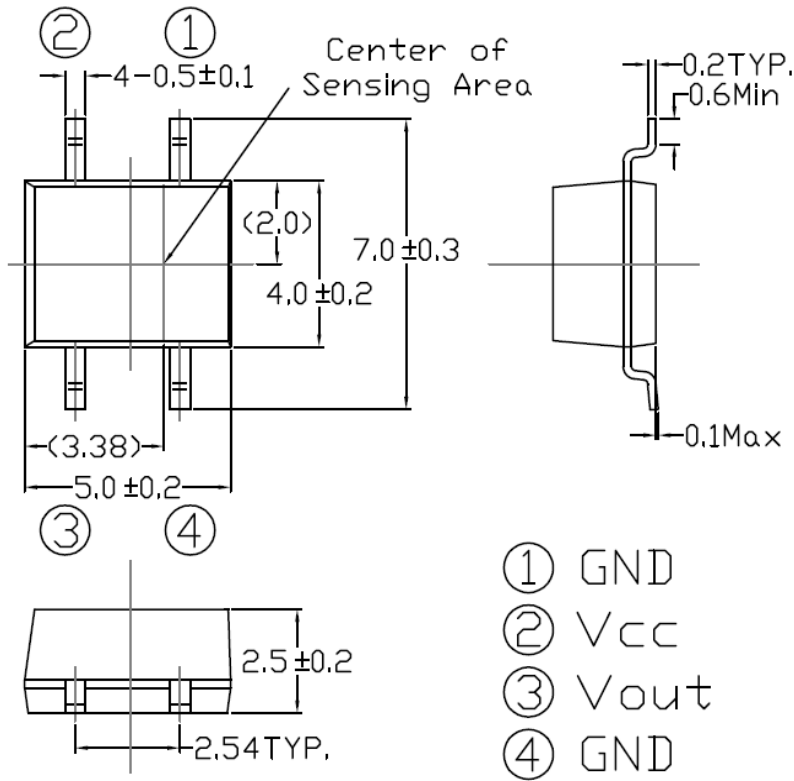

Recommended pad layout

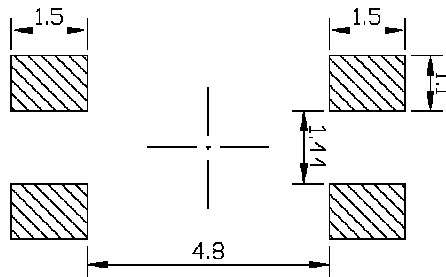

Infrared Receiver Module

IRM-H920X /TR2 series

Absolute Maximum Ratings (T_a=25°C)

Parameter	Symbol	Rating	Unit
Supply Voltage	V _{cc}	6	V
Operating Temperature	T _{opr}	-20 ~ +80	°C
Storage Temperature	T _{stg}	-40 ~ +85	°C
Soldering Temperature *1	T _{sol}	260	°C

*1 4mm from mold body for less than 10 seconds

Electro-Optical Characteristics (T_a=25°C, V_{cc}=3V)

Parameter	Symbol	MIN.	TYP.	MAX.	Unit	Condition
Current consumption	I _{cc}	0.4	0.6	0.8	mA	No input signal
Supply voltage	V _{CC}	2.5	-	5.5	V	
Reception range	L ₀	8	-	-	m	See chapter ,Test method'
	L ₄₅	5	-	-		
Half angle(horizontal)	φ _h	-	±60	-	deg	
Half angle(vertical)	φ _v	-	±60	-	deg	
Low level pulse width	T _L	100	250	450	μs	Test signal fig.1
High level output voltage	V _{OH}	V _{cc} -0.4	-	-	V	Open circuit
Low level output voltage	V _{OL}	-	0.2	0.5	V	I _{SINK} ≤ 2mA
Internal pull up resistor	R _{PU}	-	52	-	kΩ	

Test method

The specified electro-optical characteristics are valid under the following conditions.

1. Measurement environment
A place without extreme light reflections.
2. External light
The environment contains an ordinary, white fluorescent lamp without high frequency modulation. The color temperature is 2856K and the illumination at the IR receiver is less than 10 Lux ($E_v \leq 10\text{Lux}$).
3. the radiant intensity of the standard transmitter is 100mWsr
4. The measurement system is shown in Fig.-3

Fig.-1 Transmitter Wave Form

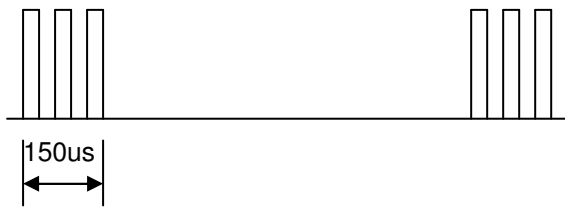

D.U.T output Pulse



Fig.-2 Measuring System

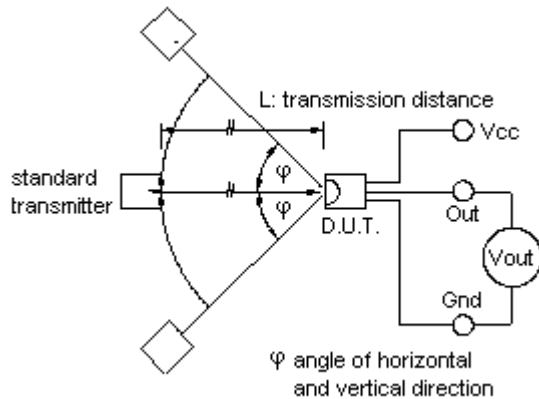

Typical Performance Curves

Fig.-4 Relative Responsibility vs. Wavelength

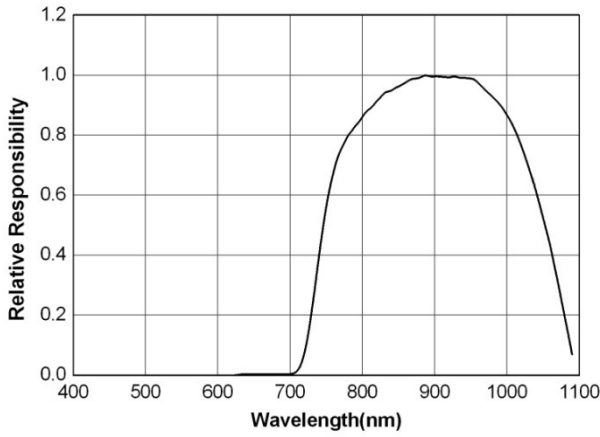

Fig.-5 Relative Transmission Distance vs. Direction

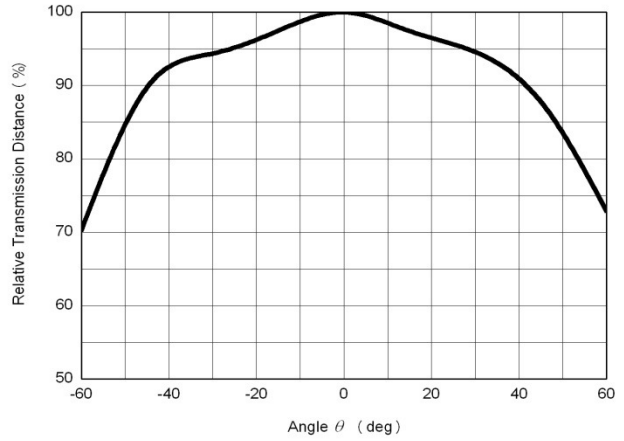

Fig.-6 Output Pulse Width vs. Transmission Distance

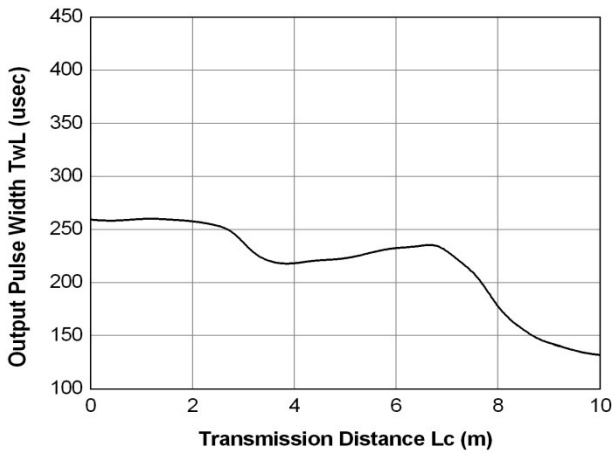

Fig.-7 Relative Transmission Distance vs. Supply Voltage

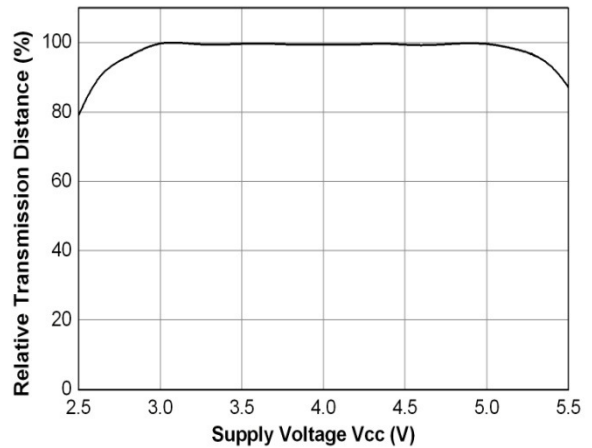
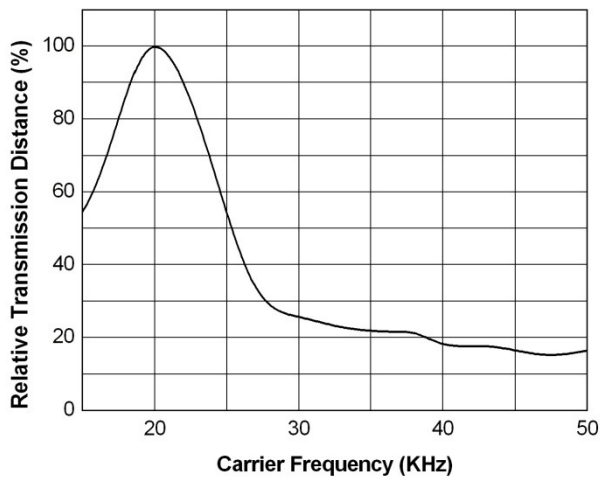

Fig.-8 Relative Transmission Distance vs. Carrier Frequency



Infrared Receiver Module

IRM-H920X /TR2 series

Device Marking

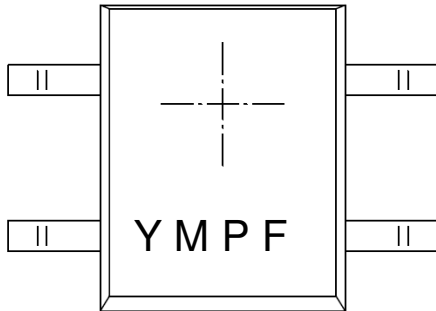

Notes

- Y denotes Year code
- M denotes month code
- P denotes device number
- F denotes frequency

Tape & Reel Packing Specifications

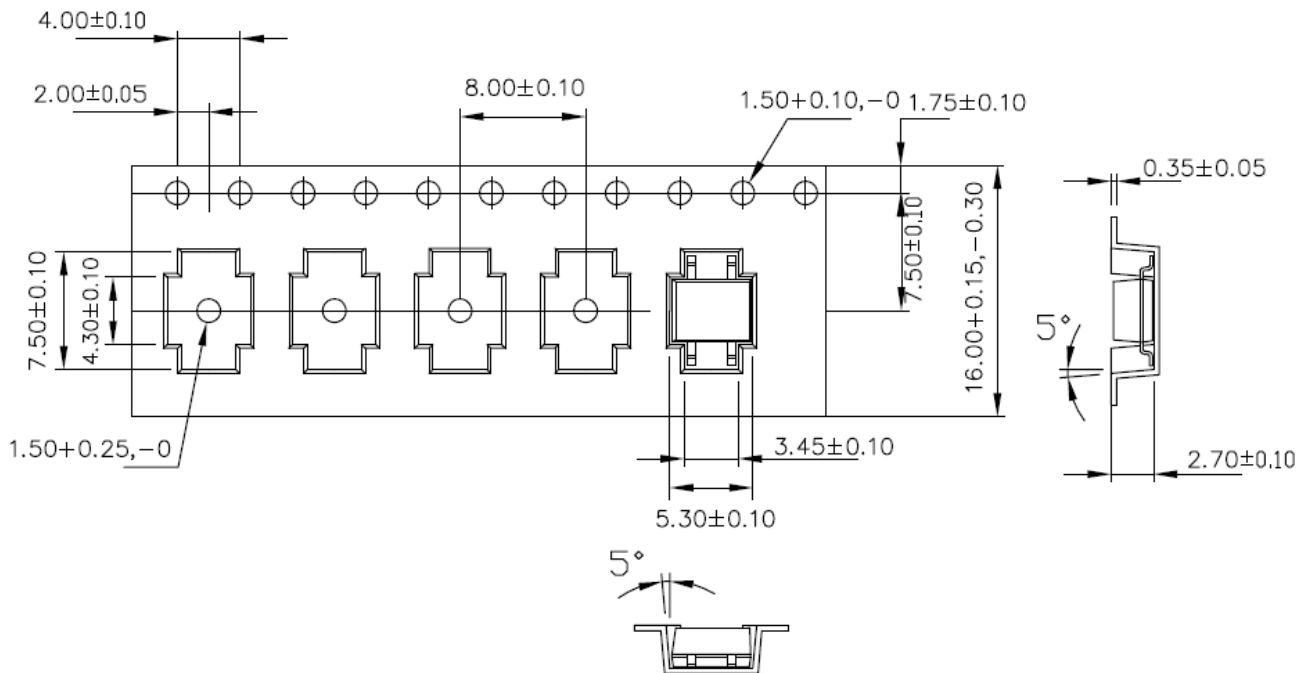

Packing Quantity

1000 pcs / Reel

5 Reels / Carton

Infrared Receiver Module

IRM-H920X /TR2 series

Label format

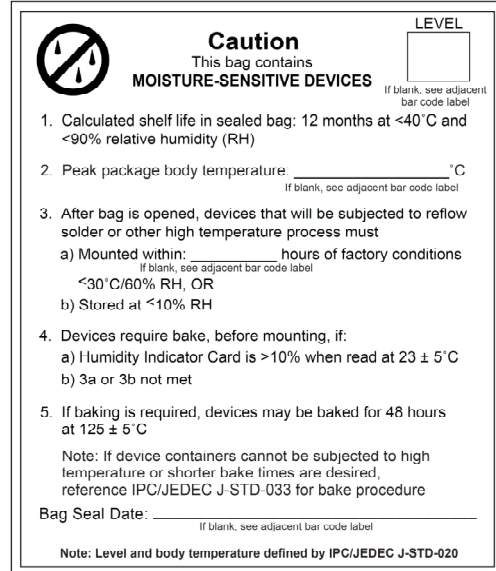
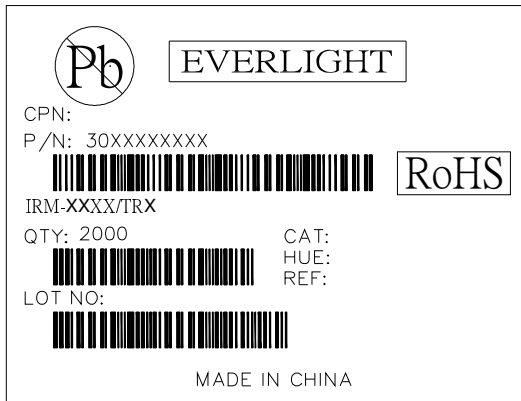

Moisture Classification-storage and used condition label

Recommended method of storage

The following are general recommendations for moisture sensitive level (MSL) 4 storage and use:

1. Shelf life in sealed bag from the bag seal date: 12 months at < 40 °C and < 90% relative humidity (RH)
2. After bag is opened, devices that will be subjected to reflow solder or other high temperature process must mounted within 72 hours of factory conditions < 30 °C/60%RH.
3. If the moisture absorbent material (silica gel) has faded away or the IRM has exceeded the storage time. Baking treatment is required, refer to IPC/JEDEC J-STD-033 for bake procedure or recommend the conditions: 60±5°C for 96 hours.

ESD Precaution

Proper storage and handing procedures should be followed to prevent ESD damage to the devices especially when they are removed from the Anti-static bag. Electro-Static Sensitive Devices warning labels are on the packing.

Solder Reflow Temperature Profile

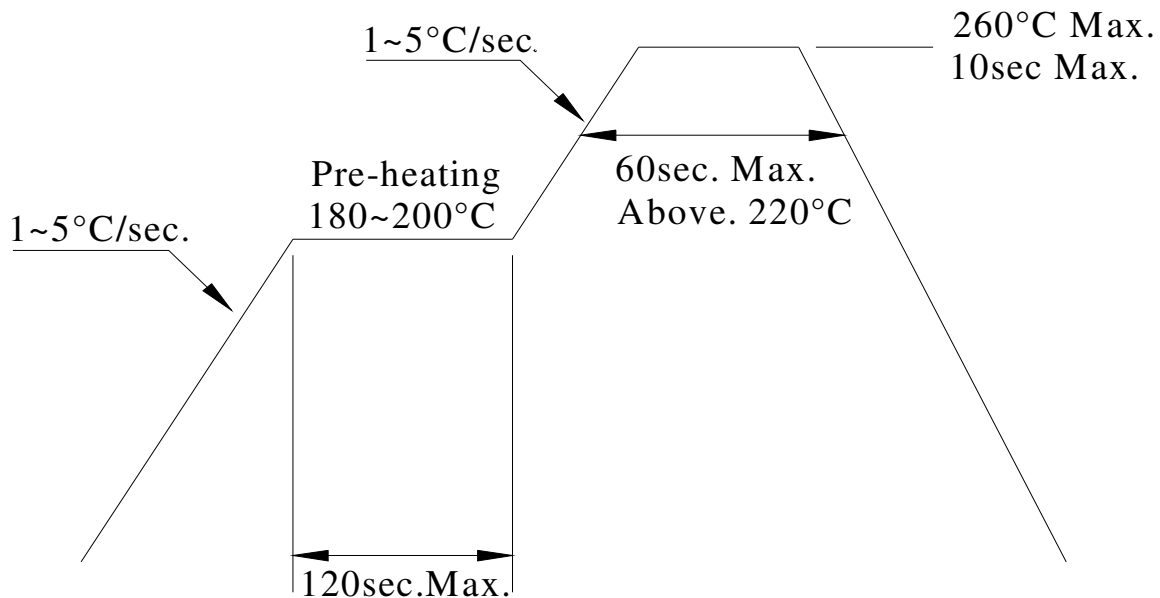

Note:

1. Reflow soldering should not be done more than two times.
2. When soldering, do not put stress on the IRM device during heating.
3. After soldering, do not warp the circuit board.

DISCLAIMER

1. Above specification may be changed without notice. EVERLIGHT will reserve authority on material change for above specification.
2. When using this product, please observe the absolute maximum ratings and the instructions for use outlined in these specification sheets. EVERLIGHT assumes no responsibility for any damage resulting from use of the product which does not comply with the absolute maximum ratings and the instructions included in these specification sheets.
3. These specification sheets include materials protected under copyright of EVERLIGHT. Reproduction in any form is prohibited without the specific consent of EVERLIGHT.